

Available from now on!

- Everything you need to connect the Elektror **Air Knife!**
- New device connector for **standardized** connections!

**System components
for mechanical connection**

- For blowers and side channel blowers -



Don't miss this connection!

Never before the mechanical connection of your blower or side channel blower was that easy!

No matter if operating your Elektror devices in combination with an Elektror *Air Knife* or if they are integrated into your system with pipings - as of now the mechanical connection will be much easier!

We enlarged our product range for you!

From now on we offer all accessories you need to mechanically connect your Elektror device to your system or to the Elektror *Air Knife*.

These are our new accessories:



Standardized device connector

- Suitable for HT pipes/fittings and spiral hoses
- Appropriate for discharge and intake side
- Available for many types of Elektror devices (see list on page 3)
- Made of solid aluminium cast



HT fittings

- Suitable for standardized device connector
- Standardized diameters
- Different forms available (see list on pages 4/5)



Spiral hose

- Suitable for standardized device connector
- Various lengths and diameters available
- Further characteristics and available types see page 6



Spiral hose clamps

- Suitable for spiral hose
- Available sizes see page 6



Available device connectors

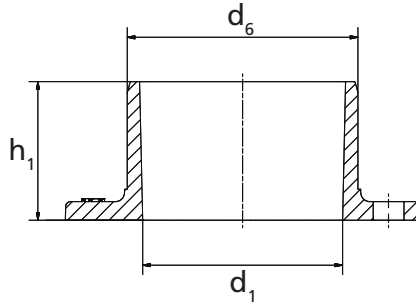

Type	Connector discharge side				Connector intake side			
	d_1 [mm]	d_6 [mm]	h_1 [mm]	Article-No.	d_1 [mm]	d_6 [mm]	h_1 [mm]	Article No.
Side channel blowers								
SD 24, SD 4n								
SD 42, SD 400	45	50	50	001230	45	50	50	001230
SD 420								
SD 5 - SD 5400								
SD 6 - SD 600	46	50	50	013294	46	50	50	013294
SD 6200 - SD 6400								
SD 7 - SD 740	65	75	60	017382	65	75	60	017382
SD 8 - SD 820								
SD 120, SD 140	100	109	75	017365	100	109	75	017365
Medium pressure blowers								
RD 10	65	75	45	017362	70	75	90	017366
RD 14	100	109	75	017363	100	109	75	017365
RD 16	100	109	75	017365	-	-	-	-
RD 2, RD 4	100	109	75	017365	100	109	75	017365
RD 5	100	109	75	017365	-	-	-	-
RD 6	100	109	75	017365	-	-	-	-
High pressure blowers								
HRD 1/2-1/5T								
HRD 1T FU	65	75	45	017362	70	75	90	017366
HRD 14/2-5T								
HRD 14T FU	100	109	75	017363	100	109	75	017365
HRD 16T FU	100	109	75	017365	-	-	-	-
HRD 2/3-5T								
HRD 2T FU	100	109	75	017365	100	109	75	017365
HRD 60/3-7								
HRD 60 FU	100	109	75	017365	-	-	-	-

You can find further dimensions in our latest catalogues and on www.elektor.com under „Accessories“.



Suitable HT fittings

HT fittings

- Suitable for direct connection to standardized device connector
- Standardized sizes and diameters
(DIN EN 1451-1 respectively DIN 19560-10)
- Pressure and vacuum stable
- Heat-resistant, permanently flame-retardant (DIN 4102 B1)
- Resistance to chemicals (DIN 8078)
- Sealing ring according to DIN EN 681
- Corrosion-resistant and wear-proof
- Many forms, lengths, diameters etc. available
- High availability
- Very inexpensive

Bend 87°

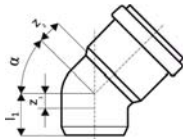

DN	Z ₁ [mm]	Z ₂ [mm]	l ₁ [mm]	Article No.
Ø50	27	31	89,5	017345
Ø75	39	43	105	017346
Ø110	57	61	133	017347

Branch 45°

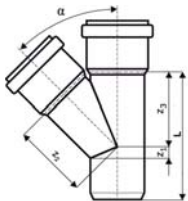

DN	Z ₁ [mm]	Z ₂ [mm]	Z ₃ [mm]	L [mm]	Article No.
Ø50/50	12	12	61	130	017348
Ø75/75	17	91	91	168	017349
Ø110/110	25	133	133	226	017350



Suitable HT fittings

Branch 87°

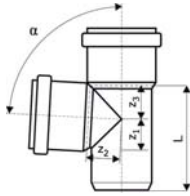

DN	Z ₁ [mm]	Z ₂ [mm]	Z ₃ [mm]	L [mm]	Article No.
Ø50/50	27	29	29	114	017351
Ø75/75	39	43	43	142	017352
Ø110/110	57	61	61	185	017353

Coupler

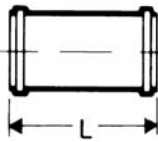

DN	L [mm]	Article No.
Ø50	112	017354
Ø75	118	017355
Ø110	140	017356

Pipe plain end

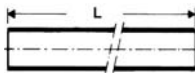

DN	L [mm]	Article No.
Ø50	125	017402
Ø75	125	017358
Ø110	125	017359

Reducer / Eccentric

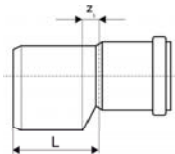

DN	Z ₁ [mm]	L [mm]	Article No.
Ø75/50	20	78	017360
Ø110/75	39	91	017361

Lubricant (for simple and quick assembly)



Quantity	Article No.
150g	017364



Spiral hose and suitable spiral hose clamps

Spiral hose - medium-heavy model



- Appropriate for food, pharmaceutical and chemical industry
- Highly abrasion-proof, smooth interior, optimized flow properties, flexible, high tensile strength and tear resistant
- Also for abrasive solids like dusts, powder, fibers, shavings and granules

Applications: Abrasion-proof suction and transport hose
Construction: Medium-heavy model
Material: Special premium ether-polyurethane
Temperature: -40 °C approx. to +90 °C approx.
Colour: Transparent (standard)

Inside -Ø [mm]	Outside -Ø [mm]	Material thickness [mm]	Operating pressure [bar / 20°C]	Vacuum [bar / 20°C]	Bending radius [mm]	Article No.		
						1m	3m	5m
50	58	0,9	1,37	0,36	64	017367	017368	017369
75	84	0,9	0,92	0,19	92	017370	017371	017372
110	119	0,9	0,63	0,11	131	017373	017374	017375

Spiral hose clamps



- Special clamp for attachment of exterior corrugated spiral hoses

Material: Clamp band and housing: stainless steel 1.4016;
 Screw: galvanized steel; Bridge: stainless steel 1.4301

Inside-Ø hose [mm]	Clamp area [mm]	Width of band [mm]	Article No.
50 - 55	45 - 65	9	017376
70 - 75	65 - 85	9	017377
110 - 115	105 - 125	9	017378

The Elektror *Air Knife*

The ideal complement for blowers and side channel blowers

The Elektror *Air Knife* creates a uniform air flow or air curtain and directs the air targeted and perfectly dosed to the required spot.

Applications for the Elektror *Air Knife* e.g.:

- **Drying:** removal of water or residual moisture from cans, bottles etc.
- **Cooling:** of plastic products, metal components etc.
- **Cleaning:** removal of production residues/shavings in machine components or similar.
- **Blow out and off:** dust removal in packaging processes.

Get the complete *Air Knife* package now!

Until today in some cases in-house developments were necessary to connect the *Air Knife* to a blower/side channel blower and to your system. Sometimes the required parts were not available at Elektror.

In combination with our new standardized device connector, the HT fittings as well as spiral hose and spiral hose clamps the *Air Knife* and blower/side channel blower become an integrated system - everything you need is now available at Elektror.



Available Elektror *Air Knives*



Description	L1	L2	D	B1	B2	Article No.
AK 200 Niro/1-50	200	80	50	130	160	016299
AK 400 Niro/1-50	400	80	50	130	160	015775
AK 400 Niro/1-110*	400	80	100	130	160	017451
AK 600 Niro/1-110*	600	80	100	130	160	017452
AK 800 Niro/1-110*	800	80	100	130	160	017453
AK 1000 Niro/1-110*	1000	80	100	130	160	017454
AK 1200 Niro/1-110*	1200	80	100	130	160	017455
AK 1500 Niro/1-110*	1500	80	100	130	160	017456
AK 1600 Niro/1-110*	1600	80	100	130	160	017457
AK 1800 Niro/1-110*	1800	80	100	130	160	017458
AK 2000 Niro/2-110*	2000	80	100	130	160	017459

*also available with D=100 mm, all other dimensions remain unchanged



System components
for blowers and side channel blowers

We got your customized solution.
Contact us!

Elektor airsystems gmbh
Hellmuth-Hirth-Str. 2
D-73760 Ostfildern
Tel.: +49 (0)711 31973-0
Fax: +49 (0)711 31973-5000
info@elektor.com
www.elektor.com

